



Dual P-Channel 12-V (D-S) MOSFET

PRODUCT SUMMARY

V_{DS} (V)	$r_{DS(on)}$ (Ω)	I_D (A)
-12	0.370 @ $V_{GS} = -4.5$ V	-1.15
	0.575 @ $V_{GS} = -2.5$ V	-0.92
	0.800 @ $V_{GS} = -1.8$ V	-0.78

FEATURES

- TrenchFET® Power MOSFETS: 1.8-V Rated
- ESD Protected: 3000 V
- Thermally Enhanced SC-70 Package

APPLICATIONS

- Load Switching
- PA Switch
- Level Switch

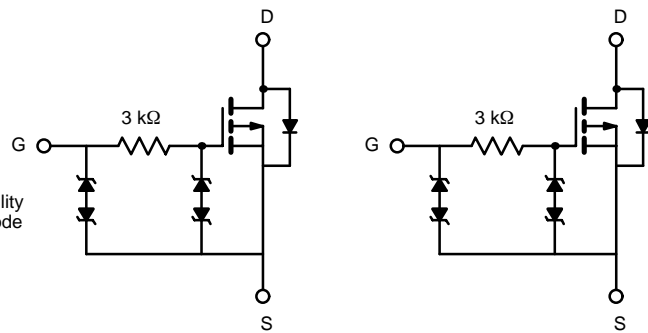
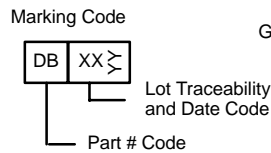
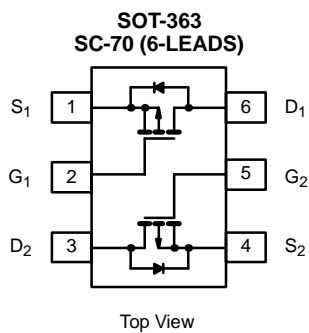

ABSOLUTE MAXIMUM RATINGS ($T_A = 25^\circ\text{C}$ UNLESS OTHERWISE NOTED)

Parameter		Symbol	5 secs	Steady State	Unit
Drain-Source Voltage		V_{DS}	-12		V
Gate-Source Voltage		V_{GS}	± 12		
Continuous Drain Current ($T_J = 150^\circ\text{C}$) ^a	$T_A = 25^\circ\text{C}$	I_D	-1.15	-1.00	A
	$T_A = 85^\circ\text{C}$		-0.83	-0.73	
Pulsed Drain Current		I_{DM}	-3		
Continuous Diode Current (Diode Conduction) ^a		I_S	-0.61	-0.47	W
Maximum Power Dissipation ^a	$T_A = 25^\circ\text{C}$	P_D	0.73	0.57	
	$T_A = 85^\circ\text{C}$		0.38	0.30	
Operating Junction and Storage Temperature Range		T_J, T_{stg}	-55 to 150		$^\circ\text{C}$

THERMAL RESISTANCE RATINGS

Parameter		Symbol	Typical	Maximum	Unit
Maximum Junction-to-Ambient ^a	$t \leq 5$ sec	R_{thJA}	130	170	$^\circ\text{C/W}$
	Steady State		170	220	
Maximum Junction-to-Foot (Drain)		R_{thJF}	80	100	

Notes

a. Surface Mounted on 1" x 1" FR4 Board.

SPECIFICATIONS ($T_J = 25^\circ\text{C}$ UNLESS OTHERWISE NOTED)

Parameter	Symbol	Test Condition	Min	Typ	Max	Unit
Static						
Gate Threshold Voltage	$V_{GS(th)}$	$V_{DS} = V_{GS}, I_D = -100\ \mu\text{A}$	-0.45			V
Gate-Body Leakage	I_{GSS}	$V_{DS} = 0\ \text{V}, V_{GS} = \pm 4.5\ \text{V}$			± 1.5	μA
		$V_{DS} = 0\ \text{V}, V_{GS} = \pm 12\ \text{V}$			± 10	mA
Zero Gate Voltage Drain Current	I_{DSS}	$V_{DS} = -9.6\ \text{V}, V_{GS} = 0\ \text{V}$			-1	μA
		$V_{DS} = -9.6\ \text{V}, V_{GS} = 0\ \text{V}, T_J = 85^\circ\text{C}$			-5	
On-State Drain Current ^a	$I_{D(on)}$	$V_{DS} = -5\ \text{V}, V_{GS} = -4.5\ \text{V}$	-2			A
Drain-Source On-State Resistance ^a	$r_{DS(on)}$	$V_{GS} = -4.5\ \text{V}, I_D = -1.0\ \text{A}$		0.300	0.370	Ω
		$V_{GS} = -2.5\ \text{V}, I_D = -0.81\ \text{A}$		0.470	0.575	
		$V_{GS} = -1.8\ \text{V}, I_D = -0.2\ \text{A}$		0.660	0.800	
Forward Transconductance ^a	g_{fs}	$V_{DS} = -10\ \text{V}, I_D = -1.0\ \text{A}$		1.7		S
Diode Forward Voltage ^a	V_{SD}	$I_S = -0.47\ \text{A}, V_{GS} = 0\ \text{V}$		-0.85	-1.2	V
Dynamic^b						
Total Gate Charge	Q_g	$V_{DS} = -6\ \text{V}, V_{GS} = -4.5\ \text{V}, I_D = -1.0\ \text{A}$		1.3	2.0	nC
Gate-Source Charge	Q_{gs}			0.31		
Gate-Drain Charge	Q_{gd}			0.31		
Turn-On Delay Time	$t_{d(on)}$	$V_{DD} = -6\ \text{V}, R_L = 12\ \Omega$ $I_D \cong -0.5\ \text{A}, V_{GEN} = -4.5\ \text{V}, R_G = 6\ \Omega$		0.17	0.26	μs
Rise Time	t_r			0.47	0.71	
Turn-Off Delay Time	$t_{d(off)}$			0.96	1.4	
Fall Time	t_f			1.0	1.5	

Notes

- a. Pulse test; pulse width $\leq 300\ \mu\text{s}$, duty cycle $\leq 2\%$.
b. Guaranteed by design, not subject to production testing.

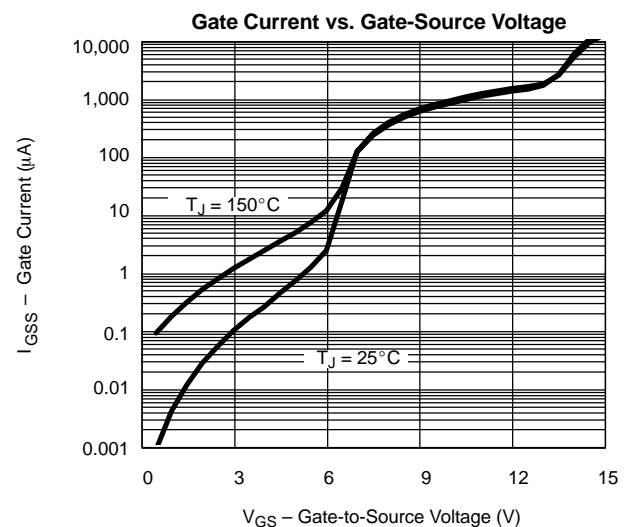
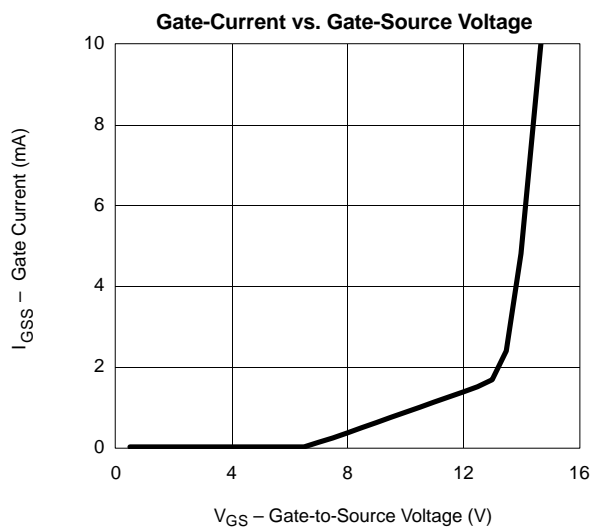
TYPICAL CHARACTERISTICS (25°C UNLESS NOTED)



TYPICAL CHARACTERISTICS (25°C UNLESS NOTED)

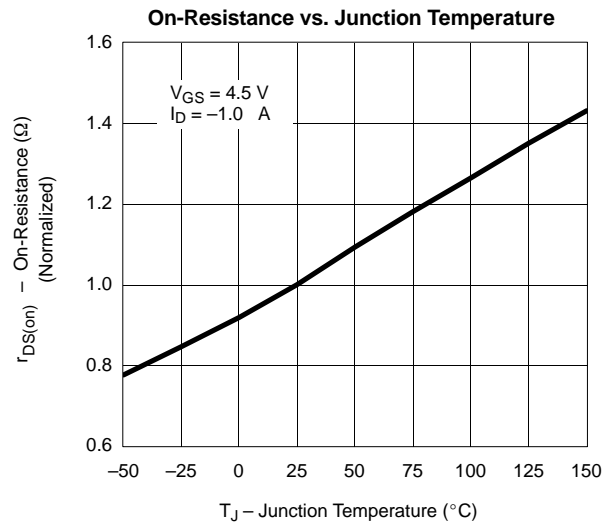
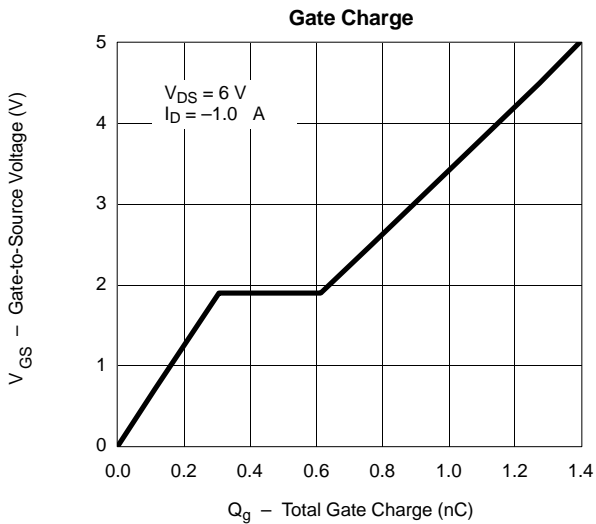
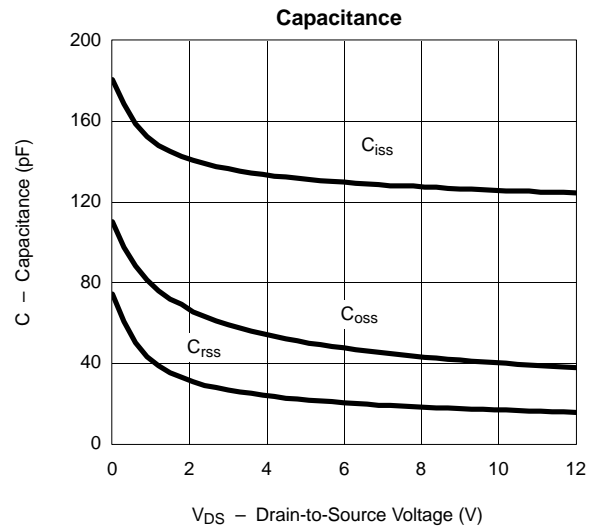
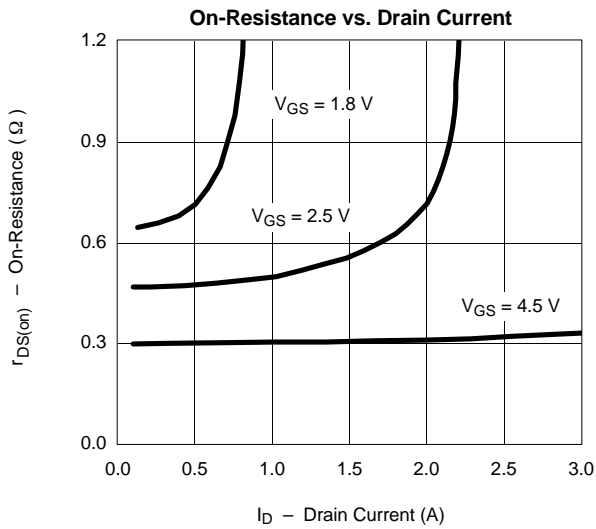
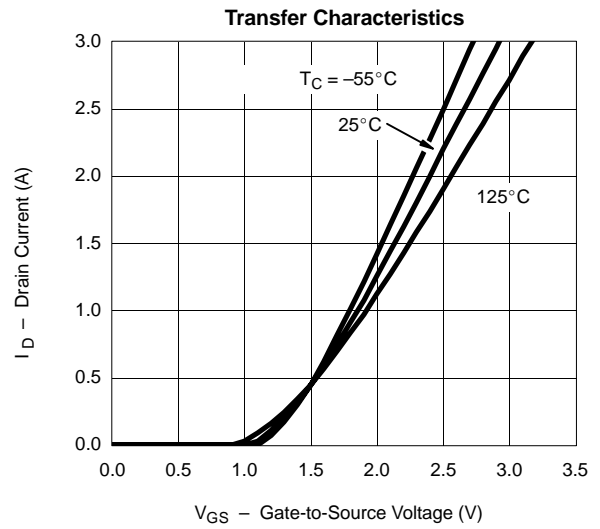
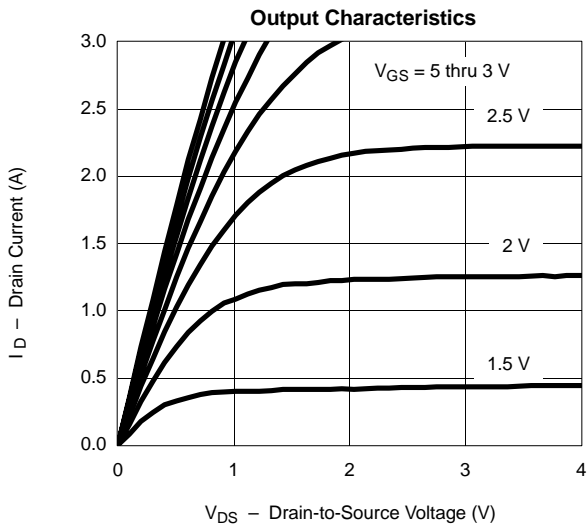

TYPICAL CHARACTERISTICS (25°C UNLESS NOTED)

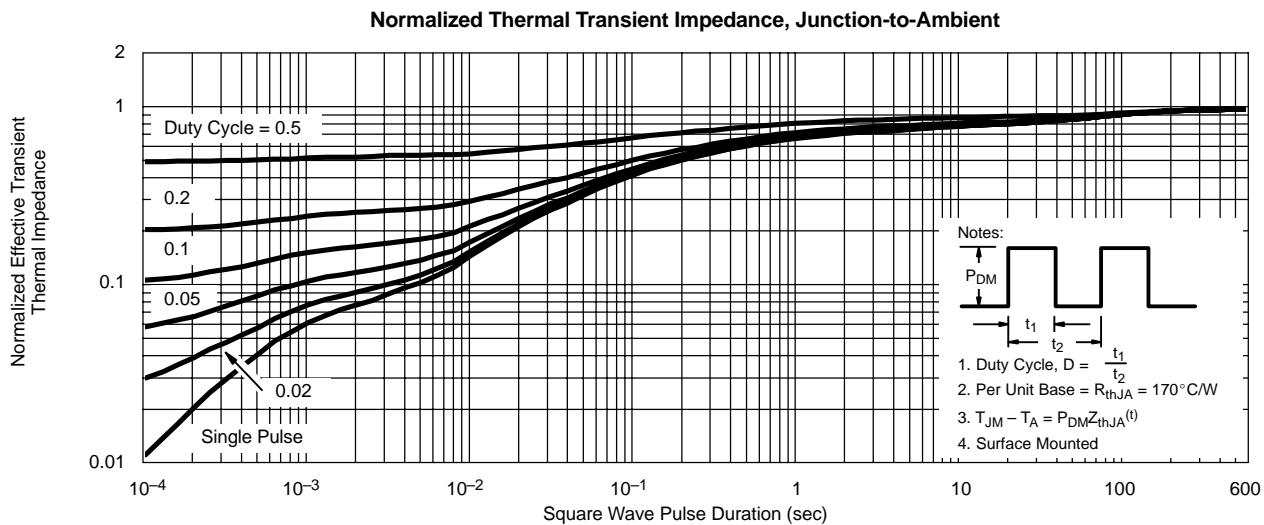
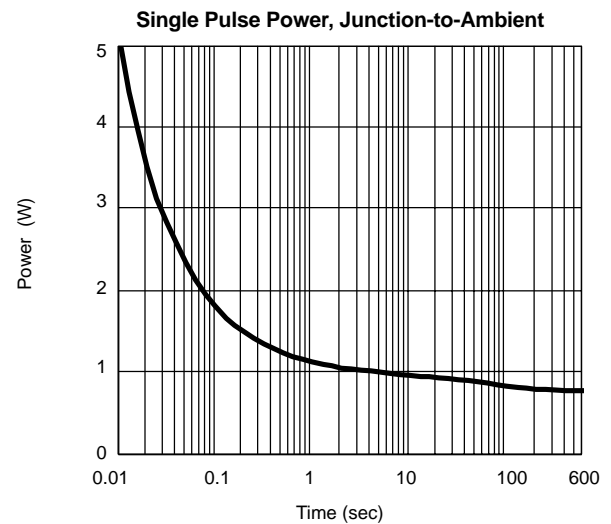
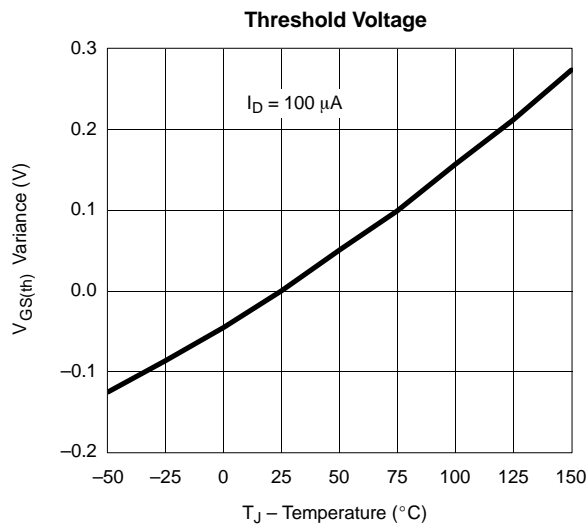
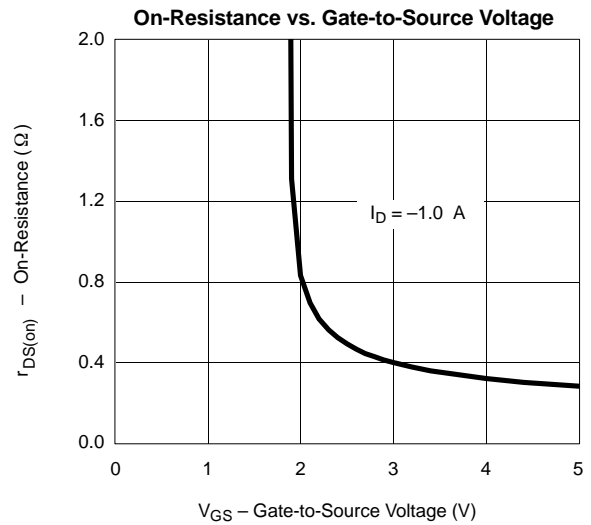
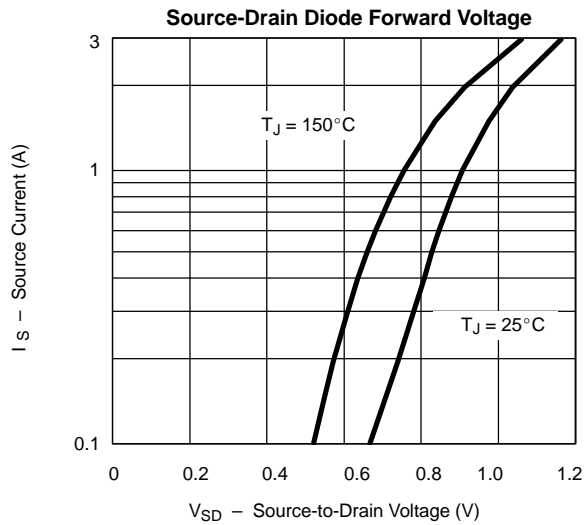



TYPICAL CHARACTERISTICS (25 °C UNLESS NOTED)

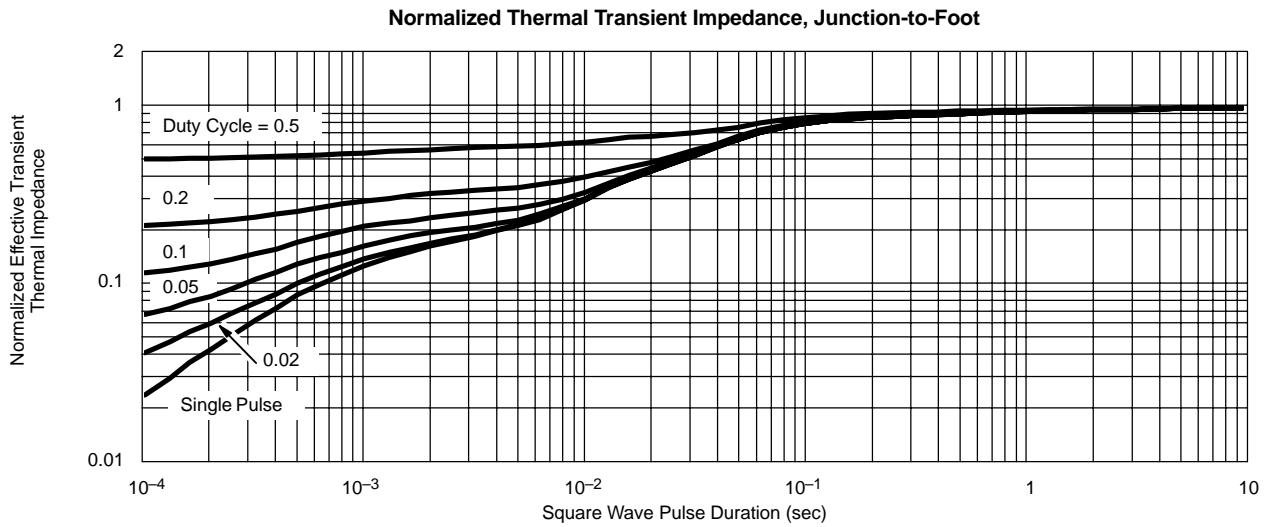



Disclaimer

All product specifications and data are subject to change without notice.

Vishay Intertechnology, Inc., its affiliates, agents, and employees, and all persons acting on its or their behalf (collectively, "Vishay"), disclaim any and all liability for any errors, inaccuracies or incompleteness contained herein or in any other disclosure relating to any product.

Vishay disclaims any and all liability arising out of the use or application of any product described herein or of any information provided herein to the maximum extent permitted by law. The product specifications do not expand or otherwise modify Vishay's terms and conditions of purchase, including but not limited to the warranty expressed therein, which apply to these products.

No license, express or implied, by estoppel or otherwise, to any intellectual property rights is granted by this document or by any conduct of Vishay.

The products shown herein are not designed for use in medical, life-saving, or life-sustaining applications unless otherwise expressly indicated. Customers using or selling Vishay products not expressly indicated for use in such applications do so entirely at their own risk and agree to fully indemnify Vishay for any damages arising or resulting from such use or sale. Please contact authorized Vishay personnel to obtain written terms and conditions regarding products designed for such applications.

Product names and markings noted herein may be trademarks of their respective owners.